

HARDWIRE FACE SHIELD

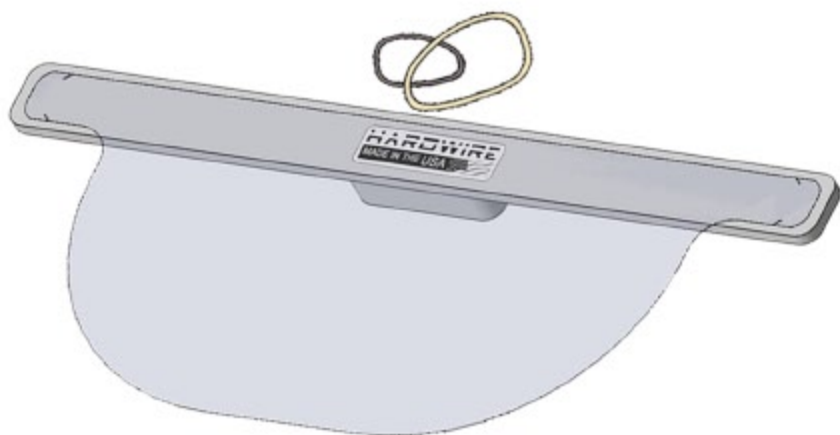

Included Items

Face shield
Closure bands

Usage Tips

Closure bands are included. Hair ties, latex free rubber bands, tape or string can also be used to close the face shield.

To clean, wipe shield and foam parts with a clean cloth and isopropyl alcohol. Do not completely submerge the mask in isopropyl alcohol.

Double wrapped closure bands or hair ties can be used to accommodate larger heads. (A)

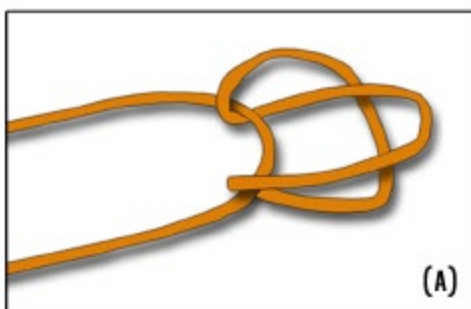

Recommended: Store flat without closure band attached.

IMPORTANT:

Before first use, press down with both hands on the forehead pad to maintain full adhesion of the foam.

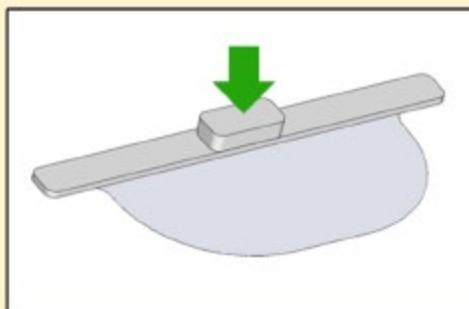

NOTE: BEFORE USE, WIPE COMPLETELY WITH ISOPROPYL ALCOHOL USING A CLEAN, LINT-FREE CLOTH OR A PRE-PACKAGED WIPE.

Product assembly instructions on reverse.

HARDWIRE LLC
hardwirellc.com

024-001-0100
MADE IN THE USA

Product Assembly Instructions

1. Locate attachment tab at rear of shield.

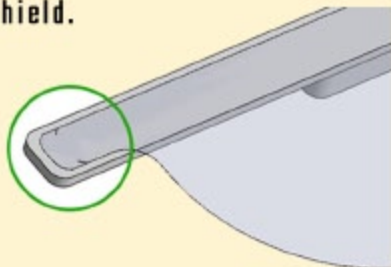

2. Pull the tab away from the foam.

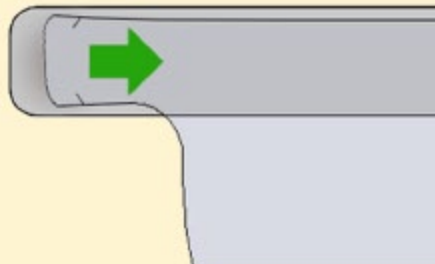

3. Insert the band under the tab.

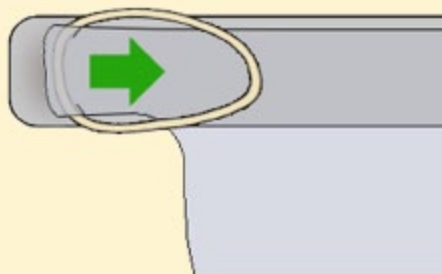

4. Pull the band tight through the tab slots.

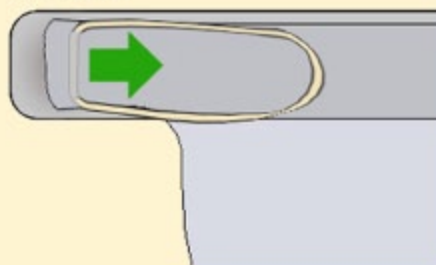

5. Release the tab and pull the band tight.



6. Repeat on the other side of the shield to make the connection.

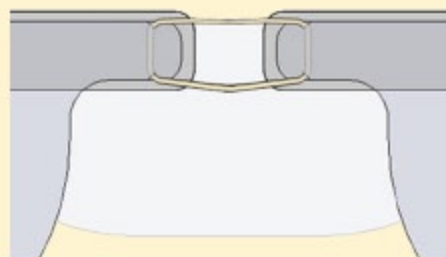

Your shield is now ready to wear.



For video instructions scan the QR code or visit www.hardwirellc.com



This Face Shield is intended for use as stand-alone Personal Protective Equipment (PPE) for medical purposes in accordance with CDC recommendations to cover the front and sides of the face and provide barrier protection. This product has been authorized by the FDA under an Emergency Use Act for use by healthcare providers as PPE under Section 564(b)(1) of the Act, 21 USC 360bbb-3(b)(1). Potentially body contacting materials contained in this product include amorphous or crystalline Polyethylene Terephthalate (PET, PET-G), Low Density Polyethylene Foam, and Latex-free Rubber. This product is intended for multiple uses, and should be cleaned in accordance with the instructions. Hardwire is an ISO 9001:2015 certified manufacturer.